

Original instructions

VOT

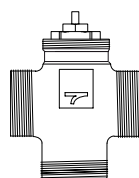

TRVS

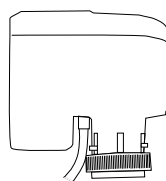

SD230

SE ... 3

GB 7

NO 11

DE 15

ES 19

FR 23

NL 27

Diagram TRVS

The valve size for water applications can be defined using the diagrams below.

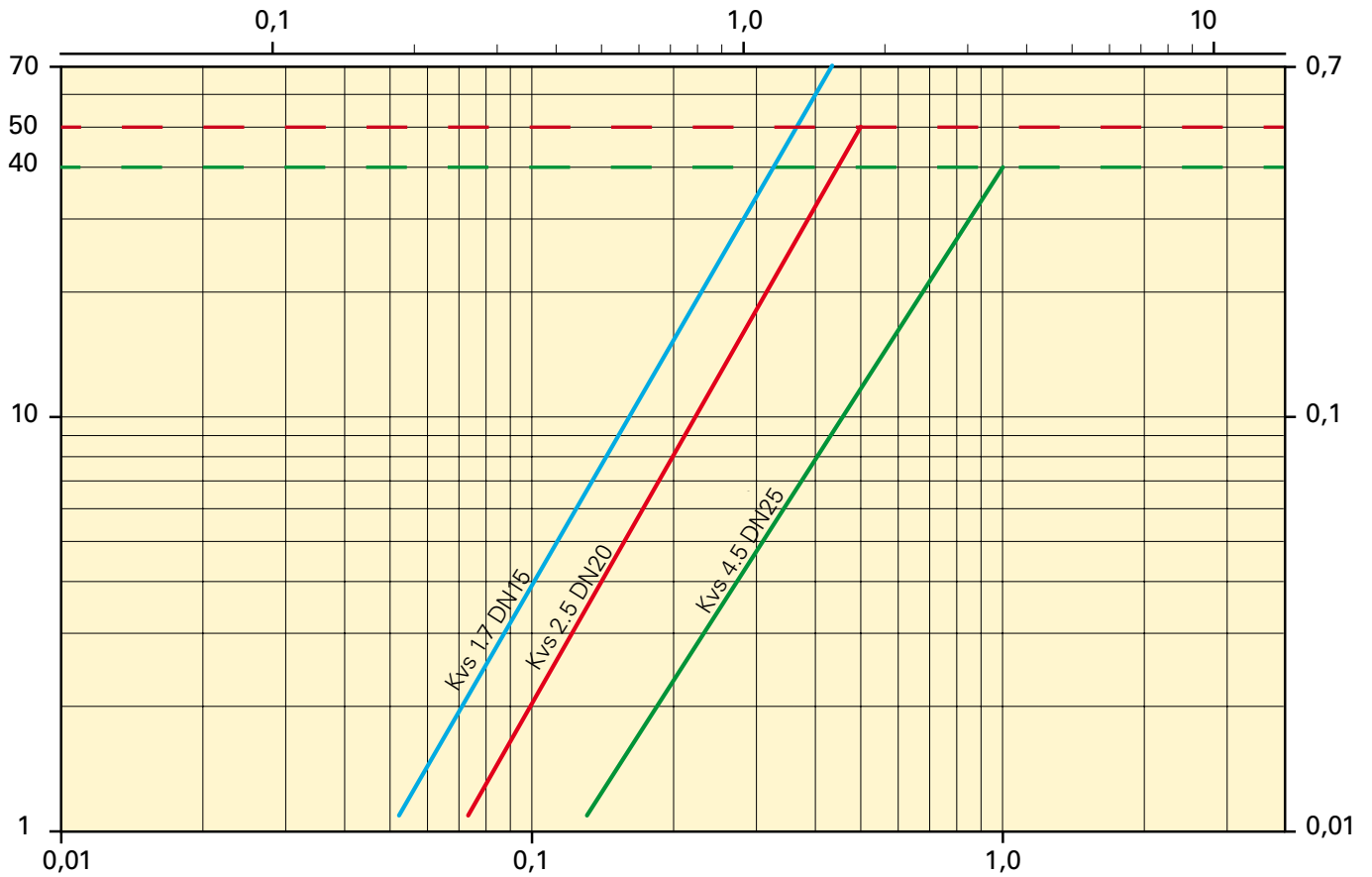

Beståndsdelar

VOT, trevägsventil och ställdon

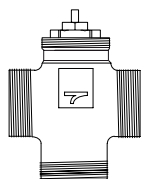

TRVS

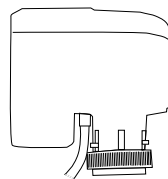

SD230

VOT15

Typ		Specifikation
TRVS15	Trevägsventil	DN15
SD230	Ställdon on/off 230V	230V~

VOT20

Typ		Specifikation
TRVS20	Trevägsventil	DN20
SD230	Ställdon on/off 230V	230V~

VOT25

Typ		Specifikation
TRVS25	Trevägsventil	DN25
SD230	Ställdon on/off 230V	230V~

VOT, trevägsventil och ställdon

Trevägsventil med on/off-ställdon.
DN15/20/25. 230V.

Består av följande:

- TRVS, trevägsventil
- SD230, ställdon on/off 230V

Trevägsventilen reglerar vattenflödet i kombination med ställdonet.

Ställdonet (SD230) reglerar värmeförseln on/off. I strömlöst läge är SD230 öppen.

Finns finns med tre olika dimensioner på ventilerna, DN15 (1/2"), DN20 (3/4") och DN25 (1").

Används med SIRE Basic och Competent eller kompletteras med lämplig termostat.

Trevägsventil (TRVS)

Dimensioner och tekniska data

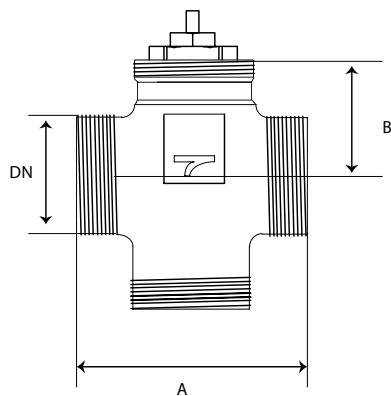

Typ	DN	A [mm]	B [mm]	Kvs*2 Reglerport	Kvs*2 Bypassport	Avstängningstryck [kPa]	Vikt [kg]
TRVS15	15	52	29	1,7 Blandning 1,7 Fördelning	1,2 Blandning 1,3 Fördelning	200	0,2
TRVS20	20	56	28	2,5 Blandning 2,6 Fördelning	1,6 Blandning 1,8 Fördelning	100	0,25
TRVS25	25	82	30,5	4,5 Blandning 4,5 Fördelning	3,1 Blandning 3,1 Fördelning	70	0,55

*2) Kvs = Flöde [m³/h] vid ett tryckfall av 1 bar och fullt öppen ventil.

Tekniska specifikationer







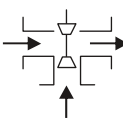

Tryckklass:	PN16
Flödeskaraktäristik:	Snabböppnande
Max tryckfall ΔP :	DN15: 70 kPa DN20: 50 kPa DN25: 40 kPa
Temperatur vätska:	2-110 °C
Omgivningstemperatur:	2-50 °C
Nominell slaglängd:	2,5 mm
Anslutning till ställdon:	M30 x 1.5
Material:	Ventilhus: EN12165 CW617 Mässing CuZn40Pb2 Spindel: AISI 303 Rostfritt stål (X10CrNiS1809) Fjäder: AISI 302 Rostfritt stål (X10CrNiS1809) Tätning: EPDM

Användningsområde

Trevägsventilen reglerar vattenflödet i kombination med ställdonet.

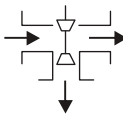
Användning

TRVS används för varmt eller kallt vatten och för vatten-glykol blandningar upp till 50%. Observera att dessa ventiler är avsedda att styra utrustning under normala driftsförhållanden.

Ventiltyp	Spindelrörelse / Flöde	
	Spindel ner	Spindel upp
 Trevägs BLANDNING 		
 Trevägs FÖRDELNING 		

Montering

Allmänna riktlinjer

Utöver allmänna installationsanvisningar, vänligen observera följande punkter:

- Var uppmärksam på ventilsens läge relativt mot strömningsriktningen.
- Observera flödessymboler på ventilhuset.

Reglerventilen bör monteras vertikalt eller horisontellt. Röret omedelbart uppströms från ventilen ska vara rakt en längd på minst 2x DN och röret omedelbart nedströms bör vara rakt en längd på minst 6x DN.

Installationen ska utföras av behörig installatör och i enlighet med denna bruksanvisning samt gällande föreskrifter.

Systemet som reglerventilen ingår i ska uppfylla rådande säkerhetskrav.

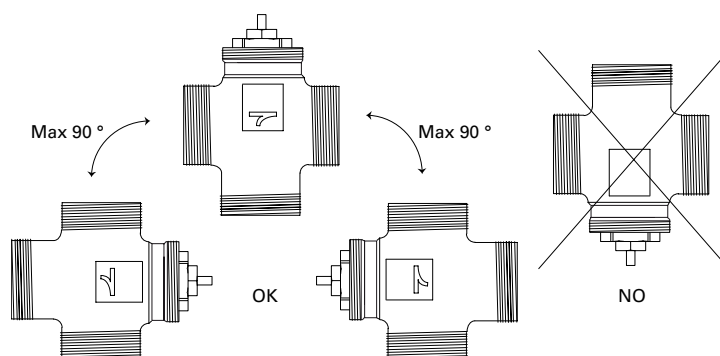

Ställdon (SD230)

Dimensioner och tekniska data

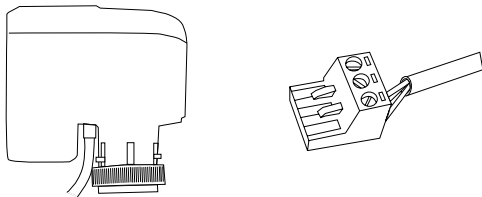

Typ	HxBxD [mm]	Vikt [kg]
SD230	81x88x56	0,2

Funktion	On/Off-reglering, linjär rörelse
Matningsspänning	230V, 50-60 Hz
Effektförbrukning	<1,5 VA i drift <0,5 VA i ändlägen
Ställkraft	100 N
Slaglängd	6,5 mm
Full tid slaglängd "On"	Ca 3 s
Full tid slaglängd "Off"	Ca 12 s
Skyddsklass	IP54
Mutter	M30x1,5
Kabellängd	1,5 m
Isoleringsklass	II
Omgivande temp.	0-60 °C

Användningsområde

Det elektriska ställdonet i kombination med ventilen används för reglering av värmetillförseln. Dess funktion är att öppna eller stänga ventilen (on/off). I strömlöst läge är SD230 öppen.

Ställdonet kan installeras och roteras efter att ventilen har installerats.

För styrning av ställdonet i kombination med ventil, kombinera med SIRE eller lämplig termostat.

Constituent parts

VOT, 3-way control valve and actuator

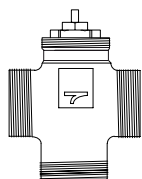

TRVS

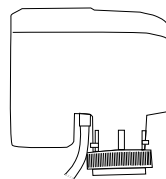

SD230

VOT15

Type	Description	Specification
TRVS15	3-way control valve	DN15
SD230	Actuator on/off 230V	230V~

VOT20

Type	Description	Specification
TRVS20	3-way control valve	DN20
SD230	Actuator on/off 230V	230V~

VOT25

Type	Description	Specification
TRVS25	3-way control valve	DN25
SD230	Actuator on/off 230V	230V~

VOT, 3-way control valve and actuator

3-way control valve with on/off actuator, DN15/20/25. 230V.

The valve set consists of the following:

- TRVS, 3-way control valve
- SD230, actuator on/off 230V

The 3-way valve and the actuator controls the waterflow.

The actuator (SD230) controls the heat supply on/off. In unpowered mode SD230 is open.

The valve set is available in three different valve dimensions, DN15 (1/2"), DN20 (3/4") and DN25 (1").

Used with SIRE Basic and Competent or supplemented with suitable thermostat

3-way control valve (TRVS)

Dimensions and technical specifications

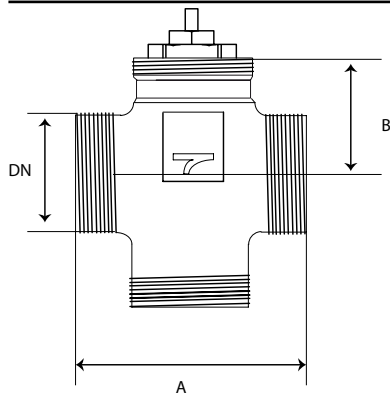

Typ	DN	A [mm]	B [mm]	Kvs*2 Control Port	Kvs*2 Bypass port	Close-off pressure [kPa]	Weight [kg]
TRVS15	15	52	29	1,7 Mixing 1,7 Diverting	1,2 Mixing 1,3 Diverting	200	0,2
TRVS20	20	56	28	2,5 Mixing 2,6 Diverting	1,6 Mixing 1,8 Diverting	100	0,25
TRVS25	25	82	30,5	4,5 Mixing 4,5 Diverting	3,1 Mixing 3,1 Diverting	70	0,55

*2) Kvs = Flow [m³/h] at a pressure drop of 1 bar and fully open valve.

Technical specifications

Body Rating: PN16
 Inherent Flow Characteristic: Quick opening
 Max Pressure drop DP: DN15: 70 kPa
 DN20: 50 kPa
 DN25: 40 kPa
 Fluid Temperature limits: 2-110 °C
 Ambient Temperature limits: 2-50 °C
 Nominal stroke: 2,5 mm
 Connection to actuators: M30 x 1.5
 Materials:

Body: EN12165 CW617 Brass CuZn40Pb2

Stem: AISI 303 Stainless Steel (X10CrNiS1809)

Spring: AISI 302 Stainless Steel (X10CrNi1809)





Plug: EPDM

Application area

The 3-way valve and the actuator controls the the waterflow.

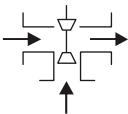
Function

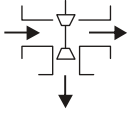
TRVS is used for hot or cold water and for water glykol mixtures up to 50 %. Note that these valves are intended to control equipment under nomal operating conditions.

Valve type	Stem movment / Flow	
	Actuator Stem down	Actuator Stem up
 3-way MIXING		
 3-way DIVERTING		

Mounting

General guidelines

In addition to general installation instructions, please observe the following points:

- Pay attention to position of the valve relative to the flow direction.
- Note flow symbols on the body.

The control valve should be installed in vertical or horizontal position. Pipe immediately upstream of the valve should be straight far the length of at least 2x DN and the pipe immediately downstream straight far the length at least 6x DN.

Installation must be performed by a licensed electrician and in accordance with these instructions and applicable regulations.

The system as a control valve is included in must meet current safety requirements.

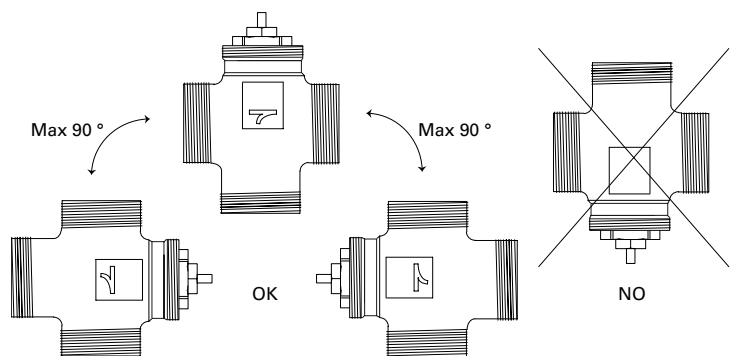

Actuator (SD230)

Dimensions and technical specifications

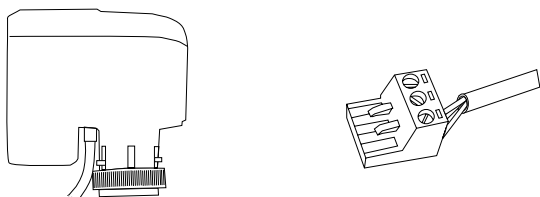

Type	HxWxD [mm]	Weight [kg]
SD230	81x88x56	0,2

Action	On/Off-regulation, linear motion
Supply voltage	230V, 50-60 Hz
Power consumption	<1,5 VA in operation <0,5 VA in the end position
Stroke force	100 N
Stroke length	6,5 mm
Full stroke time "On"	Nominal 3 s
Full stroke time "Off"	Nominal 12 s
Protection class	IP54
Screw-nut	M30x1,5
Cable length	1,5 m
Isolation class	II
Surrounding temp.	0-60 °C

Application area

The electrical actuator in combination with the valve is used for regulating the heat supply to the unit. It's function is to open or close the valve (on/off). The actuator will open the valve when power is applied.

The electrical actuator can be mounted and rotated after that the valve has been installed.

For regulating the actuator in combination with valve complement with SIRE or appropriate thermostat.

Bestanddelar

VOT, treveis reguleringsventil med aktuator

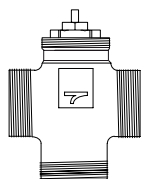

TRVS

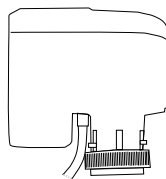

SD230

VOT15

Type		Spesifikasjon
TRVS15	3-veis reguleringsventil	DN15
SD230	Aktuator på/av 230 V	230 V~

VOT20

Type		Spesifikasjon
TRVS20	3-veis reguleringsventil	DN20
SD230	Aktuator på/av 230 V	230 V~

VOT25

Type		Spesifikasjon
TRVS25	3-veis reguleringsventil	DN25
SD230	Aktuator på/av 230 V	230 V~

VOT, treveis reguleringsventil med aktuator

Treveis reguleringsventil med på/av-aktuator, DN15/20/25. 230 V. Ventilsettet består av følgende:

- TRVS, 3-veis reguleringsventil
- SD230, aktuator på/av 230 V

Treveisventilen og aktuatoren styrer vannmengden.

Aktuatoren(SD230) regulerer varmetilførselen på/av. I av-modus er SD230 åpen.

Ventilsettet finnes i tre ulike ventilstørrelser, DN15 (1/2 tomme), DN20 (3/4 tomme) og DN25 (1 tomme). Omløpsventilen er DN10 (3/8 tomme).

Brukes med SIRE Basic og Competent eller suppleres med egnet termostat.

Treveis reguleringsventil (TRVS)

Mål og tekniske spesifikasjoner

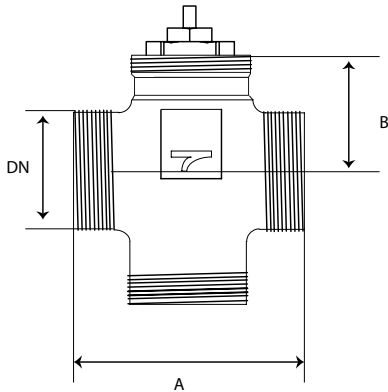

Type	DN	A [mm]	B [mm]	Kvs*2 Reguleringsport	Kvs*2 Omløpsport	Avstengingstrykk [kPa]	Weight [kg]
TRVS15	15	52	29	1,7 Blanding 1,7 Fordeling	1,2 Blanding 1,3 Fordeling	200	0,2
TRVS20	20	56	28	2,5 Blanding 2,6 Fordeling	1,6 Blanding 1,8 Fordeling	100	0,25
TRVS25	25	82	30,5	4,5 Blanding 4,5 Fordeling	3,1 Blanding 3,1 Fordeling	70	0,55

2) Kvs = Strømning ved et trykkfall på 1 bar og helt åpen ventil.

Tekniske spesifikasjoner

Trykkklasse: PN16

Strømningskjennetegn: Hurtigåpnende

Maks. trykkfall DP:

- DN15: 70 kPa
- DN20: 50 kPa
- DN25: 40 kPa

Temperaturgrense, væske: 2-110 °C

Temperaturgrense, omgivelse: 2-50 °C

Nominell slaglengde: 2,5 mm

Tilkobling til aktuatorer: M30 x 1,5

Materialer:







- Ventilhus: EN12165 CW617 Messing CuZn40Pb2
- Spindel: AISI 303 Rustfritt stål (X10CrNiS1809)
- Fjær: AISI 302 Rustfritt stål (X10CrNi1809)
- Tetning: EPDM

Bruk

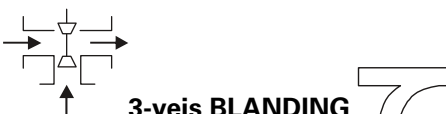
Treveisventilen og aktuatoren styrer vannmengden.

Funksjon

TRVS brukes til varmt eller kaldt vann og til vann/glykol-blandinger opptil 50 %. Vær oppmerksom på at disse ventilene er beregnet for styring av utstyr under normale driftsforhold.

Ventiltype	Spindelbevegelse / Strømning	▶ Strømning	▷ Ingen strømning
	Aktuator Spindel ned	Aktuator Spindel opp	
 3-veis BLANDING			
 3-veis FORDELING			

Montering

Generelle retningslinjer

I tillegg til generelle installasjonsanvisninger, må du også være oppmerksom på følgende punkt:

- Noter deg ventilens plassering i forhold til strømningens retning.
- Noter deg strømningssymboler på ventilhuset.

Reguleringsventilen bør installeres vertikalt eller horisontalt. Røret umiddelbart oppstrøms fra ventilen bør være rett en lengde på minst 2x DN, og røret umiddelbart nedstrøms bør være rett en lengde på minst 6x DN.

Installasjonen skal utføres av en godkjent elektriker i henhold til denne

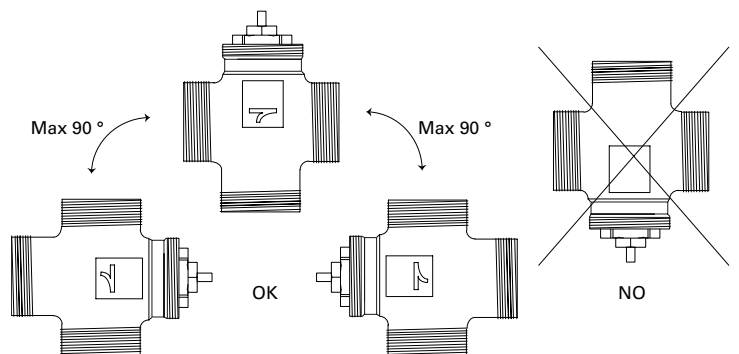

bruksanvisningen samt gjeldende forskrifter. Systemet som reguleringsventilen inngår i, skal oppfylle gjeldende sikkerhetskrav.

Aktuator (SD230)

Mål og tekniske spesifikasjoner

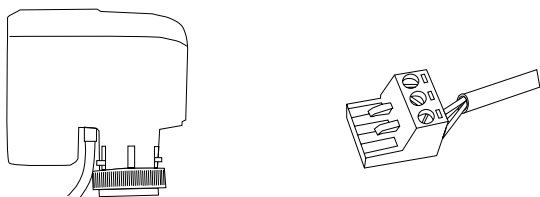

Type	HxBxD [mm]	Vekt [kg]
SD230	81x88x56	0,2

Gangretning	På/av-regulering, lineær bevegelse
Forsyningsspenning	230 V, 50–60 Hz
Strømforbruk	<1,5 VA ved drift <0,5 VA i endeposisjonen
Stengekraft	100 N
Slaglengde	6,5 mm
Full slaglengde "On"	Ca. 3 s
Full slaglengde "Off"	Ca. 12 s
Kapslingsklasse	IP54
Mutter	M30x1,5
Kabellengde	1,5 m
Isoleringsklasse	II
Omgivelsestemp.	0–60 °C

Bruk

Den elektriske aktuatoren i kombinasjon med ventilen brukes til å regulere varmetilførselen til enheten. Funksjonen den har, er å åpne eller lukke ventilen (på/av). Aktuatoren åpner ventilen når strømmen slås på.

Den elektriske aktuatoren kan påmonteres og roteres etter at ventilen er installert.

For regulering av aktuatoren i kombinasjon med ventilen kombinerer du den med SIRE eller en egnet termostat.

Bestandteile

VOT, 3-Wege-Regelventil mit Stellmotor.

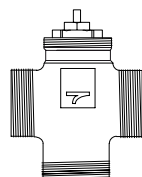

TRVS

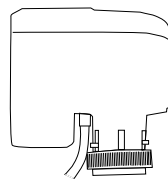

SD230

VOT15

Type	Description	Specification
TRVS15	3-way control valve	DN15
SD230	Stellmotor ein/aus 230 V	230 V~

VOT20

Type	Description	Specification
TRVS20	3-way control valve	DN20
SD230	Stellmotor ein/aus 230 V	230 V~

VOT25

Type	Description	Specification
TRVS25	3-way control valve	DN25
SD230	Stellmotor ein/aus 230 V	230 V~

VOT, 3-Wege-Regelventil mit Stellmotor.

3-Wege-Regelventil mit Stellmotor, Ein/Aus, DN15/20/25. 230V. Der Ventilsatz umfasst Folgendes:

- TRVS, 3-Wege-Regelventil
 - SD230, Stellmotor Ein/Aus 230 V
- Das 3-Wege-Regelventil und der Stellmotor steuern den Wasserfluss.

Der Stellmotor (SD230) regelt die Heizleistung ein/aus. Im antriebslosen Modus ist der SD230 offen.

Der Ventilsatz steht in drei Abmessungen zur Verfügung, DN15 (1/2 Zoll), DN20 (3/4 Zoll) und DN25 (1 Zoll). Das Bypass-Ventil entspricht DN10 (3/8").

Wird mit SIRE Basic und Competent eingesetzt oder mit einem geeigneten Thermostat ergänzt.

3-Wege-Regelventil (TRVS)

Abmessungen und technische Daten

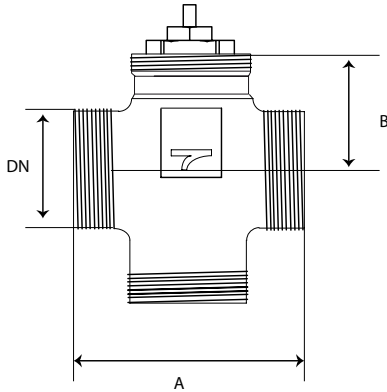

Typ	DN	A [mm]	B [mm]	Kvs*2 Anschluss Regelventil	Kvs*2 Anschluss Bypass-Ventil	Anschluss Bypass- Ventil [kPa]	Sperrdrn [kg]
TRVS15	15	52	29	1,7 Mischen 1,7 Umlenken	1,2 Mischen 1,3 Umlenken	200	0,2
TRVS20	20	56	28	2,5 Mischen 2,6 Umlenken	1,6 Mischen 1,8 Umlenken	100	0,25
TRVS25	25	82	30,5	4,5 Mischen 4,5 Umlenken	3,1 Mischen 3,1 Umlenken	70	0,55

2) Kvs = Durchfluss bei einem Druckverlust von 1 bar und vollständig geöffnetem Ventil.

Technische Daten

Dimensionierung Hauptteil: PN16

inhärente Fließeigenschaften: Maximaler

Druckverlust bei schneller Öffnung:

- DN15: 70 kPa
- DN20: 50 kPa
- DN25: 40 kPa

Grenzwerte Flüssigkeitstemperatur: 2-110 °C

Grenzwerte Umgebungstemperatur: 2-50 °C

Nennhub: 2,5 mm

Verbindung zu Stellmotoren: M30 x 1,5

Materialien:







- Hauptteil: EN12165 CW617 Messing CuZn40Pb2
- Schaft: AISI 303 Edelstahl (X10CrNiS1809)
- Feder: AISI 302 Edelstahl (X10CrNi1809)
- Verschluss: EPDM

Einsatzbereich

Das 3-Wege-Regelventil und der Stellmotor steuern den Wasserfluss.

Funktionsweise

Das TRVS wird für warmes und kaltes Wasser sowie für Wasser-Glykolgemische von bis zu 50% verwendet. Beachten Sie, dass die Ventile zur Regulierung der Geräte unter normalen Betriebsbedingungen bestimmt sind.

Ventiltyp	Schaftbewegung / Durchfluss	▶ Durchfluss ▷ kein Durchfluss
	Stellmotorschaft unten	Stellmotorschaft oben
 3-Wege-MISCHVENTIL		
 3-Wege-UMLENKVENTIL		

Montage

Allgemeine Hinweise

Zusätzlich zur allgemeinen Installationsanleitung sind auch die folgenden Punkte zu beachten:

- Achten Sie darauf, dass das Ventil der Strömungsrichtung entsprechend angebracht ist.
- Achten Sie auf die am Hauptteil angebrachten Symbole zur Fließrichtung.

Das Regelventil muss entweder senkrecht oder waagrecht angebracht werden. Das Rohr, das sich unmittelbar vor dem Ventil befindet, muss mind. 2x DN gerade verlaufen und das Rohr, das sich unmittelbar nach dem Ventil befindet, muss mind. 6x DN gerade verlaufen.

Die Installation darf nur von einem qualifizierten Elektriker gemäß der vorliegenden Anleitung und den geltenden Vorschriften durchgeführt werden.

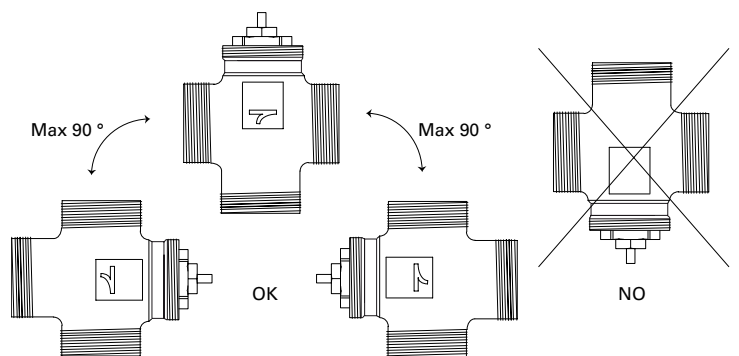

Das Regelventilsystem gehört zum Lieferumfang und muss den geltenden Sicherheitsbestimmungen entsprechen.

Stellmotor (SDM230)

Abmessungen und technische Daten

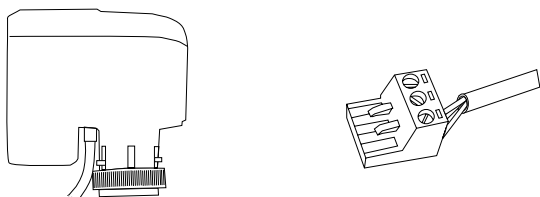

Typ	HxBxT [mm]	Gewicht [kg]
SD230	81x88x56	0,2
Maßnahme	Ein-/Aus-Steuerung, Linearbewegung	
Netzspannung	230 V, 50-60 Hz	
Stromverbrauch	<1,5 VA in Betrieb <0,5 VA in Endstellung	
Hubkraft	100 N	
Hublänge	6,5 mm	
Vollständige Schließzeit "Ein"	Sollzeit 3 s	
Vollständige Hubphase "Aus"	Sollzeit 12 s	
Schutzart	IP54	
Mutter	M30x1,5	
Kabellänge	1,5 m	
Isolationsklasse	II	
Umgebungstemperatur	0 -60 °	

Application area

Der elektrische Stellmotor wird zusammen mit dem Ventil zur Steuerung der Heizleistung des Geräts verwendet. Seine Aufgabe ist, das Ventil (ein/aus) zu öffnen bzw. zu schließen. Sobald Strom zugeführt wird, öffnet der Stellmotor das Ventil.

Nachdem das Ventil installiert worden ist, kann der elektrische Stellmotor montiert und gedreht werden.

Die gemeinsame Steuerung des Stellmotors und Ventils erfolgt durch Verwendung des SIRE oder eines entsprechenden Thermostats.

Componentes

VOT, válvula reguladora de 3 vías con actuador

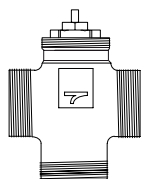

TRVS

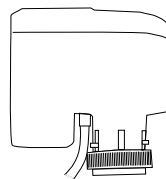

SD230

VOT15

Tipo	Características	
TRVS15	Válvula reguladora de 3 vías	DN15
SD230	Actuador on/off de 230 V	230 V~

VOT20

Tipo	Características	
TRVS20	Válvula reguladora de 3 vías	DN20
SD230	Actuador on/off de 230 V	230 V~

VOT25

Tipo	Características	
TRVS25	Válvula reguladora de 3 vías	DN25
SD230	Actuador on/off de 230 V	230 V~

VOT, válvula reguladora de 3 vías con actuador

Válvula reguladora de 3 vías con actuador on/off. DN15/20/25. 230 V. El juego consta de los elementos siguientes:

- TRVS, válvula reguladora de 3 vías
- SD230, actuador on/off de 230 V

La válvula de 3 vías y el actuador regulan el caudal de agua.

El actuador (SD230) controla el encendido/apagado de la calefacción. Cuando está apagada, el SD230 está abierto.

El juego de válvula está disponible en tres tamaños de válvula distintos: DN15 (1/2"), DN20 (3/4") y DN25 (1"). La válvula de derivación es de tamaño DN10 (3/8").

Para uso con SIRE Basic y Competent o completado con un termostato adecuado.

Válvula reguladora de 3 vías (TRVS)

Dimensiones y características técnicas

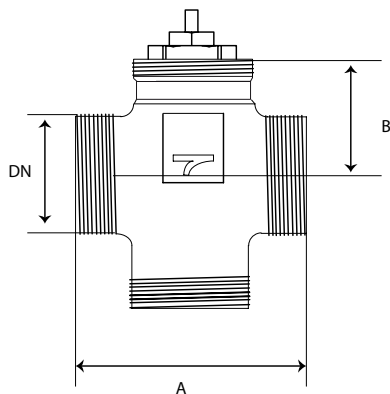

Typ	DN	A [mm]	B [mm]	Kvs*2 Lumbrera de regulación	Kvs*2 Lumbrera de bypass	Presión de cierre [kPa]	Weight [kg]
TRVS15	15	52	29	1,7 Mezcladora 1,7 Desviadora	1,2 Mezcladora 1,3 Desviadora	200	0,2
TRVS20	20	56	28	2,5 Mezcladora 2,6 Desviadora	1,6 Mezcladora 1,8 Desviadora	100	0,25
TRVS25	25	82	30,5	4,5 Mezcladora 4,5 Desviadora	3,1 Mezcladora 3,1 Desviadora	70	0,55

2) Kvs = caudal a una caída de presión de 1 bar con la válvula totalmente abierta.

Características técnicas

Clase de presión del cuerpo: PN16

Característica de caudal inherente: Apertura rápida

Caída máxima de presión DP:

- DN15: 70 kPa
- DN20: 50 kPa
- DN25: 40 kPa

Límites de temperatura del fluido: 2-110 °C

Límites de temperatura ambiente: 2-50 °C

Carrera nominal: 2,5 mm

Conexión a actuadores: M30 x 1,5

Materiales: Cuerpo: EN12165 CW617 Latón CuZn40Pb2

- Vástago: AISI 303 Acero inoxidable (X10CrNiS1809)
- Muelle: AISI 302 Acero inoxidable (X10CrNi1809)







Obturador: EPDM

Aplicación

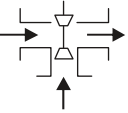
La válvula de 3 vías y el actuador regulan el caudal de agua.

Funcionamiento

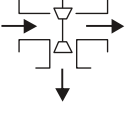
La válvula TRVS se utiliza para agua fría o caliente y para mezclas de agua y glicol al 50%. Tenga en cuenta que estas válvulas están diseñadas para regular el equipo en condiciones normales de funcionamiento.

Tipo de válvula	Movim. vástago / Caudal	▶ Caudal	▷ Sin caudal
	Actuador Vástago abajo	Actuador Vástago arriba	
 3 vías MEZCLADORA 			
 3 vías DERIVADORA 			

Montaje

Directrices generales

Además de seguir las instrucciones de instalación generales, tenga en cuenta los puntos siguientes:

- Preste atención a la posición de la válvula en relación con la dirección de caudal.
- Consulte los símbolos de caudal del cuerpo.

La válvula reguladora se debe instalar en vertical o en horizontal. La tubería situada inmediatamente antes de la válvula (dirección del caudal) no debe presentar ningún codo en una longitud mínima de 2x DN y la situada inmediatamente después de la válvula (dirección del caudal), en una longitud mínima de 6x DN.

La instalación debe encargarse a un electricista autorizado y realizarse con

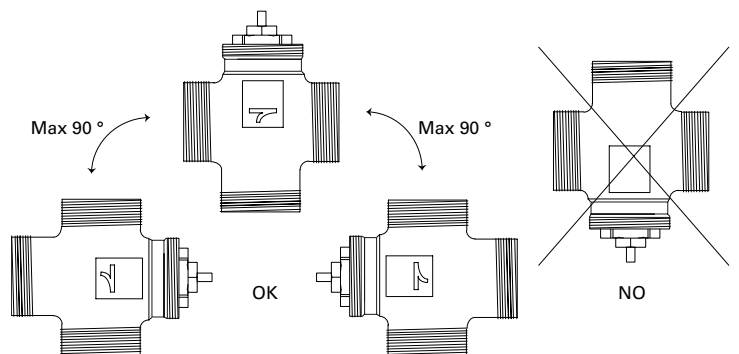

arreglo a estas instrucciones y a la normativa aplicable. El sistema en el que se monte la válvula reguladora debe seguir cumpliendo los requisitos de seguridad.

Actuador (SD230)

Dimensiones y características técnicas

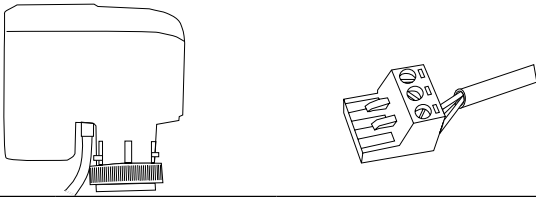

Tipo	AlxAnxF [mm]	Peso [kg]
SD230	81x88x56	0,2

Acción	Regulación on/off, movimiento lineal
Tensión de alimentación	230 V, 50-60 Hz
Consumo eléctrico	<1,5 VA en funcionamiento <0,5 VA en posición final
Fuerza de cierre	100 N
Carrera	6,5 mm
Tiempo de carrera completa "On"	3 s nominales
Tiempo de carrera completa "Off"	12 s nominales
Clase de protección	IP54
Rosca	M30x1,5
Longitud del cable	1,5 m
Clase de aislamiento	II
Temp. en proximidades	0-60 °C

Aplicación

El actuador eléctrico se utiliza con la válvula para regular el suministro de calor al aparato. Su función es abrir o cerrar la válvula (on/off). Al recibir alimentación, el actuador abre la válvula.

El actuador eléctrico se puede montar y girar después de instalar la válvula.

Para uso con SIRE o con un termostato adecuado.

Pièces constitutives

VOT, vanne de commande 3 voies avec électrovanne

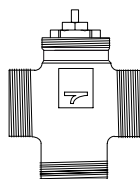

TRVS

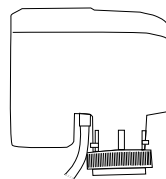

SD230

VOT15

Type	Description	Specification
TRVS15	Vanne de commande 3 voies	DN15
SD230	Électrovanne on/off 230V	230 V~

VOT20

Type	Description	Specification
TRVS20	Vanne de commande 3 voies	DN20
SD230	Électrovanne on/off 230V	230 V~

VOT25

Type	Description	Specification
TRVS25	Vanne de commande 3 voies	DN25
SD230	Électrovanne on/off 230V	230 V~

VOT, vanne de commande 3 voies avec électrovanne

Vanne de commande 3 voies avec électrovanne on/off, DN15/20/25. 230V.

L'ensemble de vannes comprend les éléments suivants :

- TRVS, vanne de commande 3 voies
- SD230, électrovanne on/off 230V

La vanne 3 voies et l'électrovanne commandent le le débit d'eau.

L'électrovanne (SD230) commande le fonctionnement marche/arrêt du chauffage. En mode hors tension, l'électrovanne SD230 est ouverte.

L'ensemble de vannes est disponible en trois dimensions de vanne différentes, DN15 (1/2"), DN20 (3/4") and DN25 (1"). La vanne de dérivation est DN10 (3/8").

Utilisé avec SIRE Basic et Competent ou doté d'un thermostat adapté.

Vanne de régulation 3 voies (TRVS)

Dimensions et caractéristiques techniques

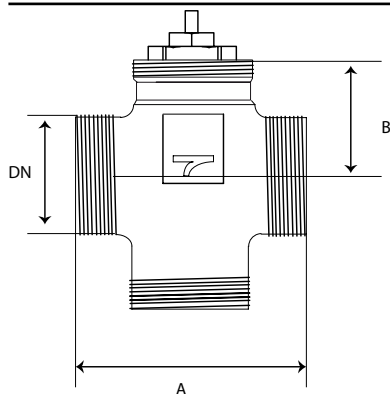

Typ	DN	A [mm]	B [mm]	Kvs*2 Vanne de commande	Kvs*2 Vanne de dérivation	Pression différentielle de fermeture [kPa]	Weight [kg]
TRVS15	15	52	29	1,7 Mélange 1,7 Répartition	1,2 Mélange 1,3 Répartition	200	0,2
TRVS20	20	56	28	2,5 Mélange 2,6 Répartition	1,6 Mélange 1,8 Répartition	100	0,25
TRVS25	25	82	30,5	4,5 Mélange 4,5 Répartition	3,1 Mélange 3,1 Répartition	70	0,55

2) Kvs = Débit pour une chute de pression de 1 bar et vanne complètement ouverte.

Caractéristiques techniques

Classe pression: PN16

Caractéristique intrinsèque: Ouverture rapide

Chute de pression DP:

- DN15 : 70 kPa
- DN20 : 50 kPa
- DN25 : 40 kPa

Limites de température du fluide: 2-110°C

Limites de température ambiante: 2-50 °C

Distance nominale: 2,5mm

Raccordement aux électrovannes: M30 x 1.5

Matériaux :







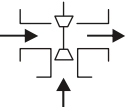

- Corps du produit : EN12165 CW617 Laiton CuZn40Pb2
- Tige : AISI 303 Acier inoxydable (X10CrNiS1809)
- Ressort : AISI 302 Acier inoxydable (X10CrNiS1809)
- Prise : EPDM

Application

La vanne 3 voies et l'électrovanne commandent le le débit d'eau.

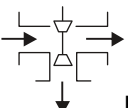
Fonction

La vanne TRVS est utilisée pour l'eau froide ou chaude et pour les mélanges eau-glycol jusqu'à 50 %. Tenez compte du fait que ces vannes sont destinées à commander des équipements dans des conditions de fonctionnement normales.

Type de vanne	Mouvement tige / Débit	▶ Débit	▷ Pas de débit
	Tige électrovanne basse	Tige électrovanne haute	
 MÉLANGE 3 voies			
 RÉPARTITION 3 voies			

Montage

Instructions générales

En complément des instructions d'installation générales, veuillez respecter les instructions suivantes :

- Prêtez attention à la position de la vanne par rapport au sens du fluide.
- Repérez les symboles relatifs au fluide sur le corps du produit.

La vanne de commande doit être installée en position verticale ou horizontale. Le tuyau situé immédiatement en amont de la vanne doit être droit sur une longueur d'au minimum 2x DN et le tuyau situé immédiatement en aval sur une longueur d'au minimum 6x DN.

L'installation doit être réalisée par un électricien professionnel conformément aux

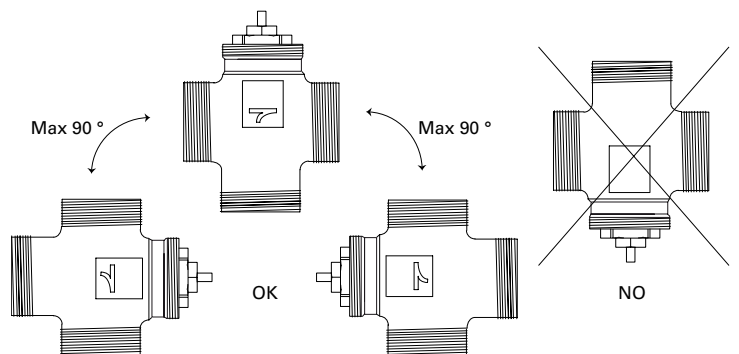

présentes instructions et aux réglementations applicables. Le système intégrant une vanne de commande doit respecter les règles de sécurité en vigueur.

Électrovanne (SD230)

Dimensions et caractéristiques techniques

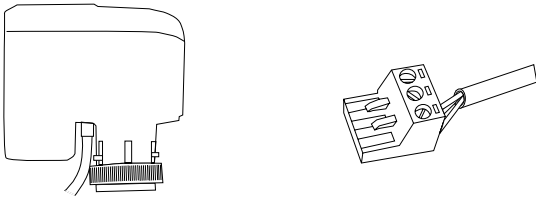

Type	HxLxP [mm]	Poids [kg]
SD230	81x88x56	0,2
Action	Régulation marche-arrêt, mouvement linéaire	
Tension d'alimentation	230 V, 50-60 Hz	
Consommation d'énergie	<1,5 VA en fonctionnement <0,5 VA en position finale	
Force de course	100 N	
Longueur de course	6,5 mm	
Durée de course maximale "On"	3 s (valeur nominale)	
Durée de course maximale "Off"	12 s (valeur nominale)	
Indice de protection	IP54	
Écrou de vis	M30x1,5	
Longueur de câble	1,5 m	
Indice d'isolement	II	
Température environnante	0-60 °C	

Application

L'électrovanne électrique, utilisée en association avec la vanne, permet de réguler l'apport de chaleur à l'unité. Elle a pour fonction d'ouvrir ou de fermer la vanne (marche/arrêt). L'électrovanne ouvre la vanne lors de la mise sous tension.

L'électrovanne électrique peut être montée et pivotée après l'installation de la vanne.

Pour réguler l'électrovanne en association avec la vanne, il convient de la compléter de SIRE ou d'un thermostat approprié.

Samenstellende delen

VOT, 3-wegregelklep met aandrijving

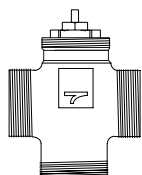

TRVS

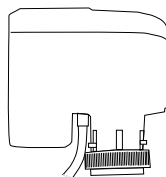

SD230

VOT15

Type		Specificatie
TRVS15	3-wegregelklep	DN15
SD230	Aandrijving aan/uit 230V	230 V~

VOT20

Type		Specificatie
TRVS20	3-wegregelklep	DN20
SD230	Aandrijving aan/uit 230V	230 V~

VOT25

Type		Specificatie
TRVS25	3-wegregelklep	DN25
SD230	Aandrijving aan/uit 230V	230 V~

VOT, 3-wegregelklep met aandrijving

3-wegregelklep met aan/uit-aandrijving, DN15/20/25. 230V. De kleppenset bestaat uit de volgende kleppen:

- TRVS, 3-wegregelklep
- SD230, aandrijving aan/uit 230V

De 3-wegklep en de aandrijving regelen de waterstroom.

De aandrijving (SD230) bestuurt de warmtetoevoer aan/uit. In de uitgeschakelde stand is SD230 open.

De kleppenset is verkrijgbaar in drie verschillende klepformaten, DN15 (1/2"), DN20 (3/4") en DN25 (1"). De omloopklep is DN10 (3/8").

Te gebruiken in combinatie met SIRE Basic en Competent of aangevuld met een geschikte thermostaat.

3-wegregelklep (TRVS)

Afmetingen en technische specificaties

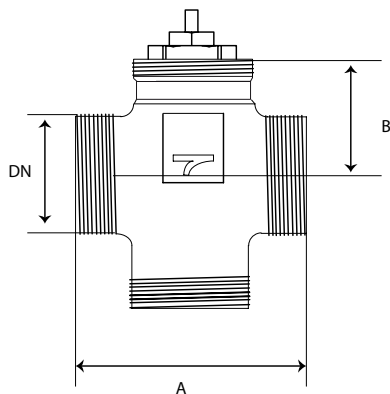

Type	DN	A [mm]	B [mm]	Kvs*2 Regelpoort	Kvs*2 Bypass-poort	Afsluitdruk [kPa]	Weight [kg]
TRVS15	15	52	29	1,7 Mengen 1,7 Omleiden	1,2 Mengen 1,3 Omleiden	200	0,2
TRVS20	20	56	28	2,5 Mengen 2,6 Omleiden	1,6 Mengen 1,8 Omleiden	100	0,25
TRVS25	25	82	30,5	4,5 Mengen 4,5 Omleiden	3,1 Mengen 3,1 Omleiden	70	0,55

2) Kvs = Strooming bij een drukval van 1 bar en een volledig geopende klep.

Technische specificaties

Drukklasse: PN16

Inherente stroomeigenschap: Snelopening

Max. drukval DP:

- DN15: 70 kPa
- DN20: 50 kPa
- DN25: 40 kPa

Temperatuur vloeistof: 2-110 °C

Omgevingstemperatuur: 2-50 °C

Nominale slag: 2,5 mm

Aansluiting op aandrijvingen: M30 x 1.5

Materialen: Behuizing: EN12165 CW617 Koper CuZn40Pb2

- Spindel: AISI 303 Roestvrij staal (X10CrNiS1809)
- Veer: AISI 302 Roestvrij staal (X10CrNiS1809)









Afdichting: EPDM

Toepassing

De 3-wegklep en de aandrijving regelen de waterstroom.

Functie

TRVS wordt gebruikt voor warm of koud water en voor mengsels van water en glycol tot 50%. Deze kleppen zijn bedoeld voor het regelen van apparatuur onder normale bedrijfsomstandigheden.

Kleptype	Spindelbeweging / Stroom	▶ Stroom	▷ Geen stroom
	Aandrijving Spindel omhoog	Aandrijving Spindel omhoog	
 3-weg MENGEN			
 3-weg OMLEIDEN			

Montage

Algemene richtlijnen

Houd naast de algemene installatie-instructies ook rekening met de volgende punten:

- Let op de positie van de klep ten opzichte van de stroomrichting.
- Let op de stroomsymbolen op de behuizing.

De regelklep moet in verticale of horizontale positie worden geïnstalleerd. De leiding direct stroomopwaarts ten opzichte van de klep moet een lengte van minimaal 2x DN recht zijn en de leiding direct stroomafwaarts moet een lengte van minimaal 6x DN recht zijn.

De installatie moet door een gecertificeerde elektricien en volgens deze instructies en de toepasselijke voorschriften worden uitgevoerd. Het systeem waarvan de regelklep deel uitmaakt moet aan de momenteel geldende veiligheidseisen voldoen.

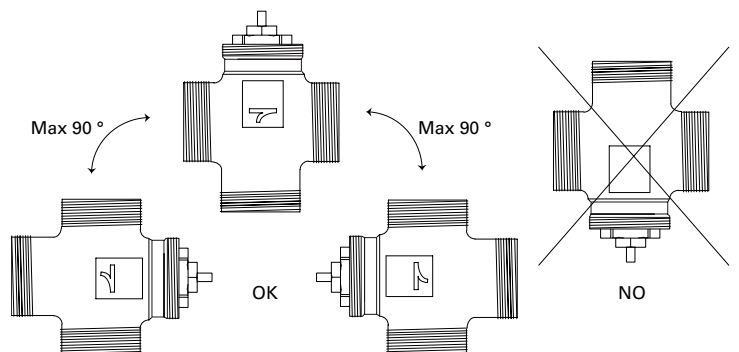

Aandrijving (SD230)

Afmetingen en technische specificaties

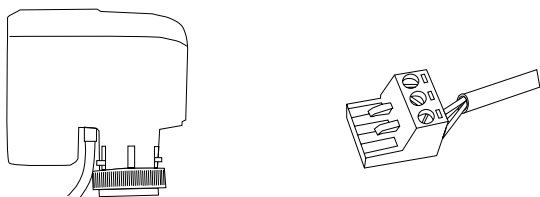

Type	HxBxD [mm]	Gewicht [kg]
SD230	81x88x56	0,2

Actie	Aan/uit-regeling, lineaire beweging
Voedingsspanning	230 V, 50-60 Hz
Stroomverbruik	<1,5 VA tijdens bedrijf <0,5 VA in de eindpositie
Sluitkracht	100 N
Sluitlengte	6,5 mm
Volledige sluittijd "Aan"	Nominaal 3 s
Volledige sluittijd "Uit"	Nominaal 12 s
Beschermklasse	IP54
Schroef-moer	M30x1,5
Kabellengte	1,5 m
Isolatieklasse	II
Omgevingstemperatuur	0-60

Toepassing

De elektrische aandrijving wordt in combinatie met de klep gebruikt voor de regeling van de warmtetoevoer naar de unit.

De functie is om de klep te openen of te sluiten (aan/uit). De aandrijving opent de klep als deze is ingeschakeld.

De elektrische aandrijving kan worden gemonteerd en geroteerd nadat de klep is geïnstalleerd.

Voor regeling van de aandrijving in combinatie met een klep voorzien van SIRE of een geschikte thermostaat.

Main office

Frico AB
Box 102
SE-433 22 Partille
Sweden

Tel: +46 31 336 86 00
Fax: +46 31 26 28 25
mailto:mailbox@frico.se
www.frico.se

**For latest updated information and information
about your local contact: www.frico.se**